

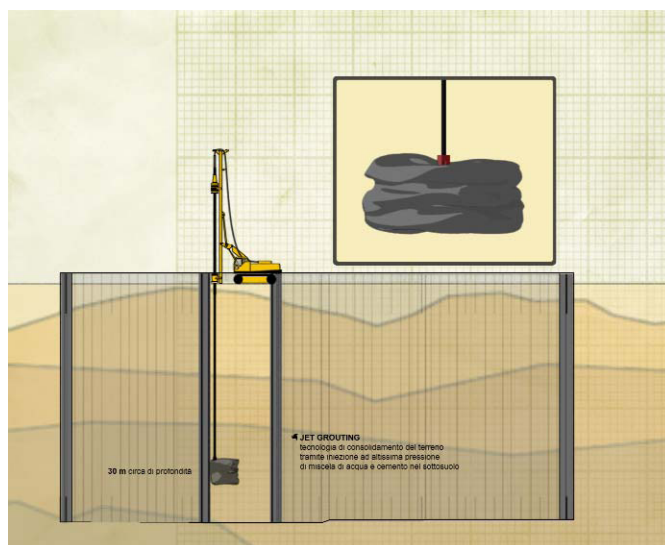

ROMA
METROPOLITANE

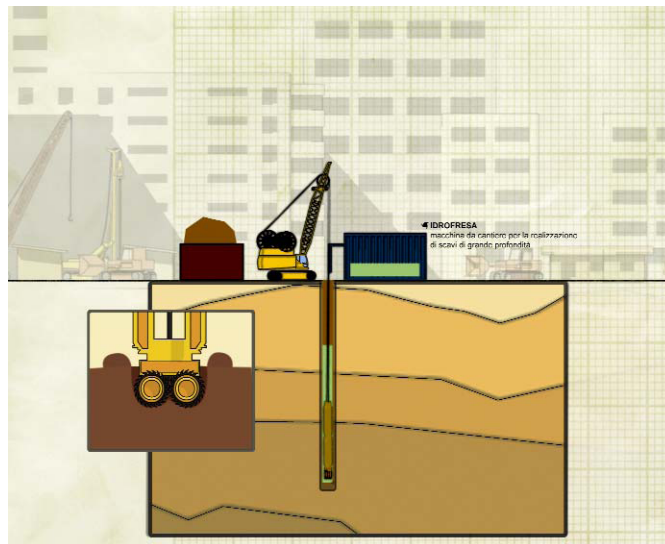
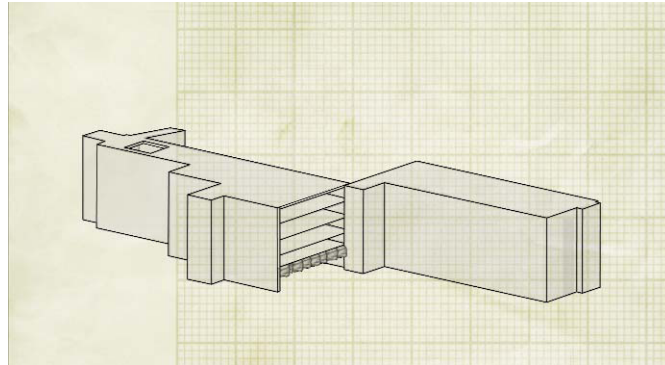

ROMA METROPOLITANE

Sede: via Tuscolana 171/173
00182 Roma
Tel. 06.454640100
Fax 06.454640111

www.romametropolitane.it



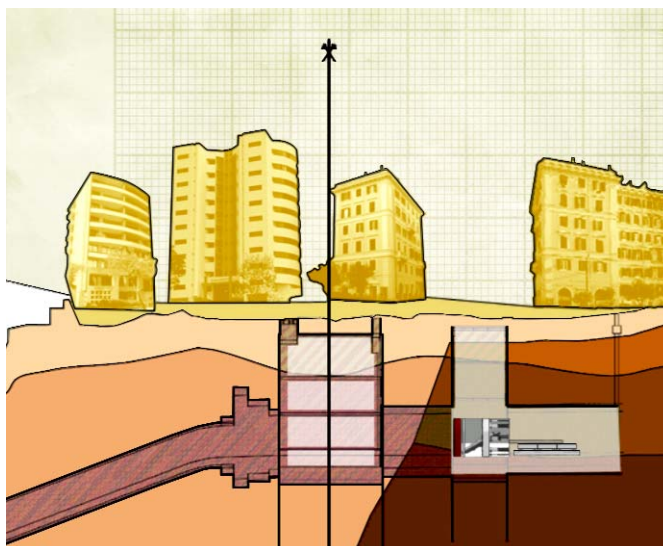
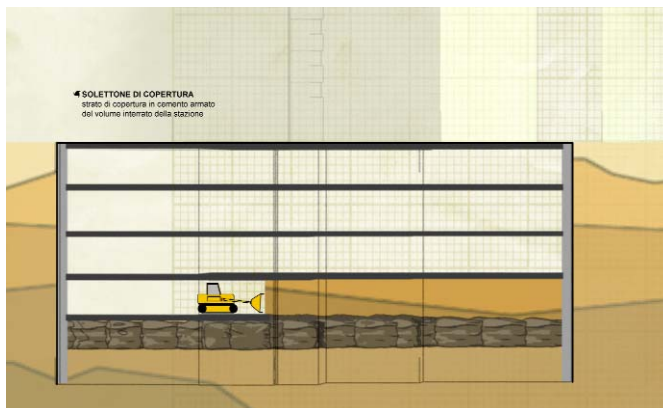
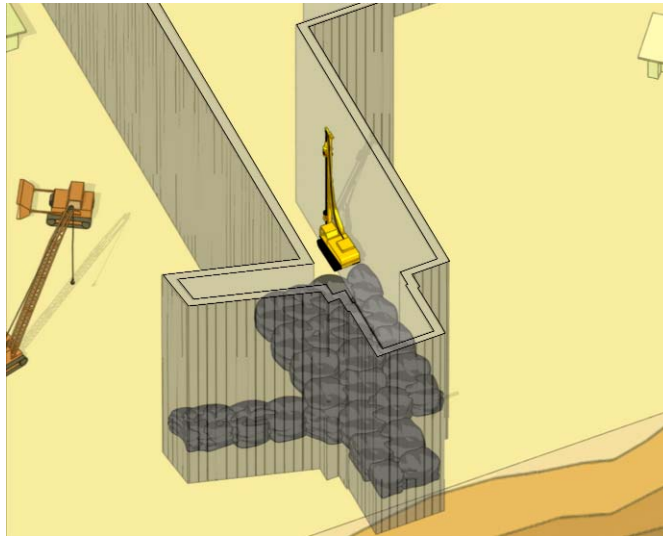

ROMA METROPOLITANE

Sede: via Tuscolana 171/173
00182 Roma
Tel. 06.454640100
Fax 06.454640111

www.romametropolitane.it

4 TESTA FRESANTE

disco circolare, che ruota a una velocità di qualche giro al minuto. Sulle teste sono presenti dei dischi (cutters) che frantumano la roccia.

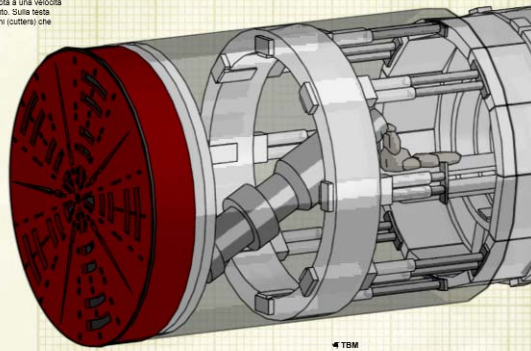

4 TBM

Tunnel Boring Machine macchina scavatrice per la realizzazione di metropolitane, acquedotti, metrocable, strade, tunnel soprattutto in ambienti urbani densamente abitati.

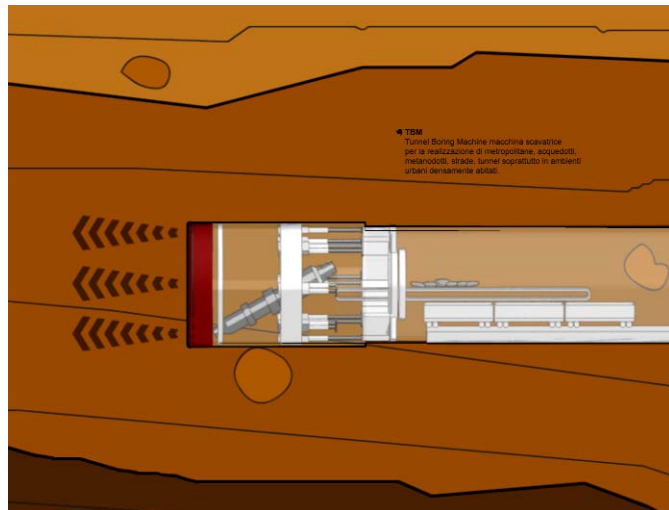

4 TBM

Tunnel Boring Machine macchina scavatrice per la realizzazione di metropolitane, acquedotti, metrocable, strade, tunnel soprattutto in ambienti urbani densamente abitati.

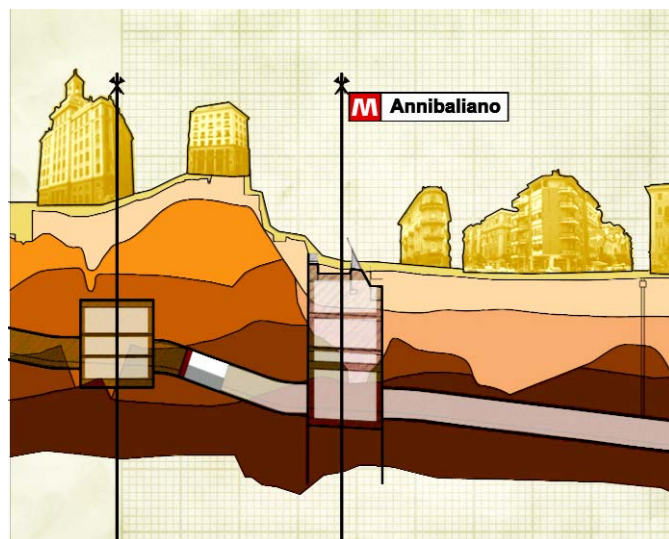

ROMA METROPOLITANE

Sede: via Tuscolana 171/173
00182 Roma
Tel. 06.454640100
Fax 06.454640111

www.romametropolitane.it